

10 kW Tower of Cool

Manage your cooling environment and achieve up to 10 kW per rack enclosure using the 10 kW Tower of Cool



Wright Line Tower of Cool uses energy efficient high flow fans to minimize power loads in the data center.

10 kW Tower of Cool Benefits for Higher Density Heat Loads

- Achieve predictable separation between the cool supply and hot return air stream
- Achieve predictable inlet temperatures to the inlet of the IT equipment
- Increase performance and lifetime of mission-critical IT equipment
- Reduce waste of valuable cool air supply
- Increase return temperatures to the cooling unit coils for greater cooling efficiency
- Deploy Paramount enclosures today and field upgrade to the 10 kW Tower of Cool when required

* Increase or change in air temperature is referred to as Delta T. Maximum rack cooling capacity is dependent on the IT equipment Delta T that resides in the rack enclosure. IT equipment will increase the temperature of the air that passes through it. A rack cooling system with IT equipment that has a low Delta T requires more air than a rack cooling system with IT equipment which has a high Delta T.

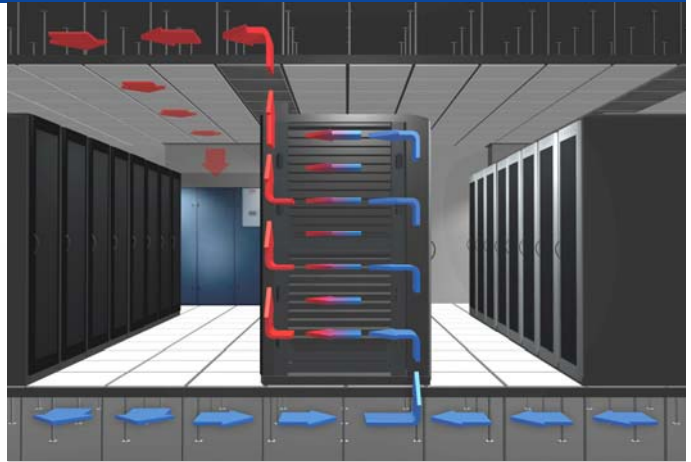

10 kW Tower of Cool Features

Required power per door: 90 watts

Maximum airflow rate per door: 740 CFM

Rack Cooling Capacity*	Equipment Delta T
10 kW	42 Degrees F
8 kW	34 Degrees F
6 kW	25 Degrees F

Specifications

Input:

120 VAC or 220 VAC, 50/60Hz, 90 Watts per door, IEC320 C14 Input Connection

Output:

740 CFM at 0" W.C.

Physical:

Attach to Paramount Enclosures, front door adds 6.50" to enclosure frame depth, rear door adds 3.50" to enclosure frame depth. Width, height and color to match Paramount enclosure.

Agency Approvals:

UL/cUL listed 60950, Information Technology Equipment



10 kW Tower of Cool For a Scalable Paramount System

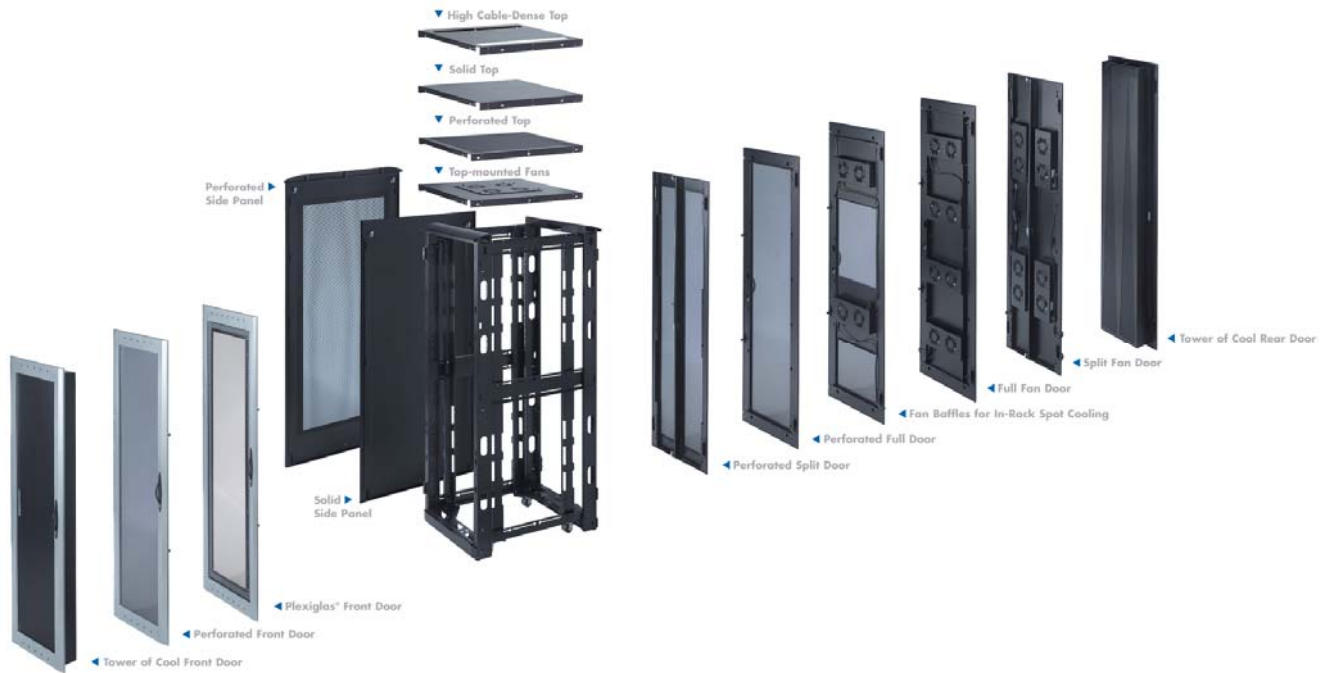

10 kW Tower of Cool Fame Components

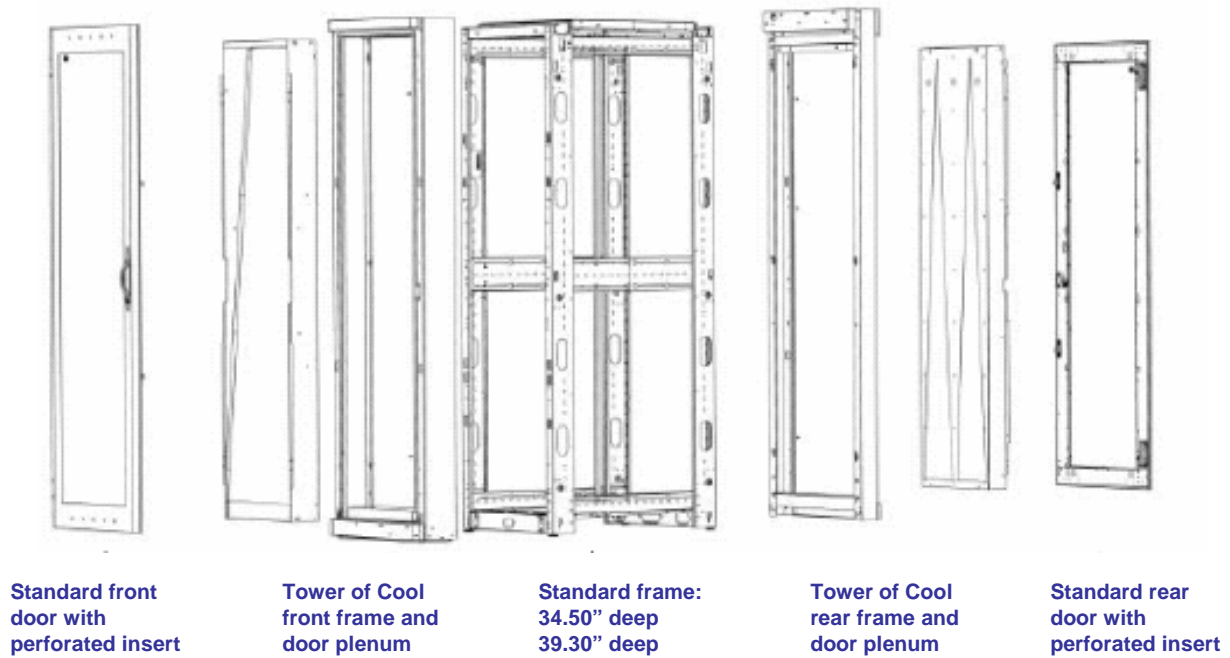

10 kW Tower of Cool Component Diagrams & Options



10 kW Tower of Cool Outline Diagram for 24" Wide 44U Enclosure

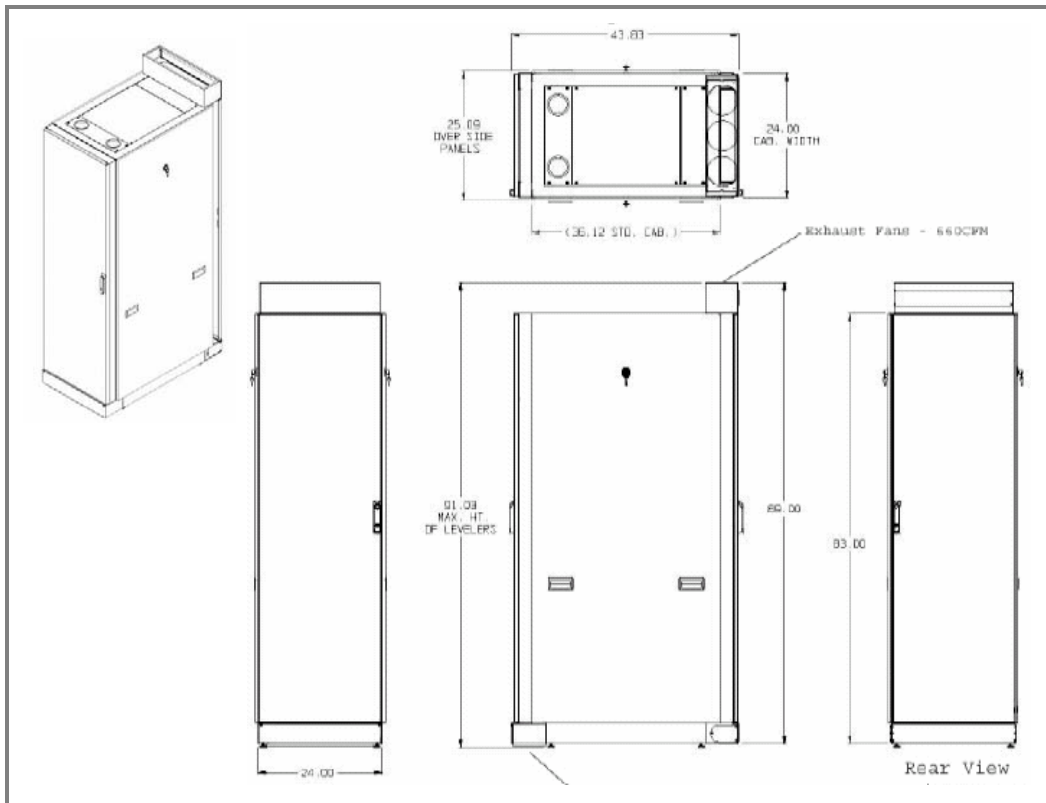

10 kW Tower of Cool (TOC) Deployment Options

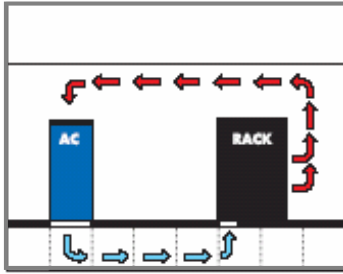

10 kW TOC FRONT DOOR

Deliver a predictable volume of conditioned air to your mission-critical IT equipment and prevent hot exhaust air from mixing with the conditioned supply air.

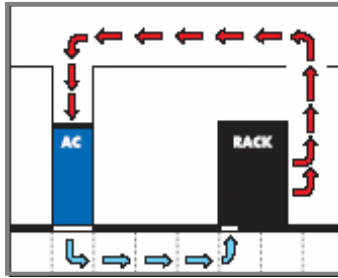

10 kW TOC FRONT DOOR & Ceiling Plenum Return

Minimize bypass with a close coupled return using the 10 kW TOC front door and optional rear door closely coupled with ceiling vent. Cooling units ducted to ceiling plenum.

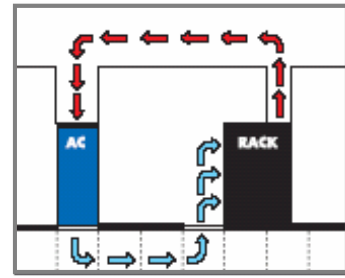

10 kW TOC REAR DOOR & Ceiling Plenum Return

Direct heated exhaust air back to the cooling unit and increase the available cool supply air by preventing cool air generated by the cooling unit from returning to the cooling unit unused.

10 kW TOC Configuration Options

24" Wide by 40U High Paramount TOC	30" Wide by 40U High Paramount TOC
<p><u>120 VAC Input Power</u></p> <p>JT7724F3 TOC FRONT FRAME 40Ux24W, 120V</p> <p>JT7724B3 TOC REAR FRAME 40Ux24W, 120V</p> <p><u>220 VAC Input Power</u></p> <p>JT7724F4 TOC FRONT FRAME 40Ux24W, 220V</p> <p>JT7724B4 TOC REAR FRAME 40Ux24W, 220V</p>	<p><u>120 VAC Input Power</u></p> <p>JT7730F3 TOC FRONT FRAME 40Ux30W, 120V</p> <p>JT7730B3 TOC REAR FRAME 40Ux30W, 120V</p> <p><u>220 VAC Input Power</u></p> <p>JT7730F4 TOC FRONT FRAME 40Ux30W, 220V</p> <p>JT7730B4 TOC REAR FRAME 40Ux30W, 220V</p>
24" Wide by 44U High Paramount TOC	30" Wide by 44U High Paramount TOC
<p><u>120 VAC Input Power</u></p> <p>JT8424F3 TOC FRONT FRAME 44Ux24W, 120V</p> <p>JT8424B3 TOC REAR FRAME 44Ux24W, 120V</p> <p><u>220 VAC Input Power</u></p> <p>JT8424F4 TOC FRONT FRAME 44Ux24W, 220V</p> <p>JT8424B4 TOC REAR FRAME 44Ux24W, 220V</p>	<p><u>120 VAC Input Power</u></p> <p>JT8430F3 TOC FRONT FRAME 44Ux30W, 120V</p> <p>JT8430B3 TOC REAR FRAME 44Ux30W, 120V</p> <p><u>220 VAC Input Power</u></p> <p>JT8430F4 TOC FRONT FRAME 44Ux30W, 220V</p> <p>JT8430B4 TOC REAR FRAME 44Ux30W, 220V</p>